

Type-2 Fuzzy Braking-Torque Electronic Stability Control for Four-Wheel Independent Drive Electric Vehicles

J. Sharifi^{1*} and A. Amirjamshidy²

1,2 Electrical and Computer Engineering Department, Qom University of Technology, Qom, Iran,

sharifi@qut.ac.ir

Abstract

The electronic stability control (ESC) system is one of the most important active safety systems in vehicles. Here, we intend to improve the Electronic stability of four in-wheel motor drive electric vehicles. We will design an electronic stability control system based on Type-2 fuzzy logic controller. Since, Type-2 fuzzy controller has uncertainty in input interval furthermore of output fuzziness, it behaves like a robust control, hence it is suitable for control of nonlinear uncertain systems which uncertainty may be due to parameter variation or un-modeled dynamics. The controller output for stabilization of vehicle is corrective yaw moment. Controller output is the torque that distribute by braking and acceleration on both sides of the vehicle. We simulate our designs on MATLAB software. Some drive maneuvers will be carry to validate system performance in vehicle stability maintenance. Simulation results indicate that distributed torque-brake control strategy based on Type-2 fuzzy logic controller can improve the stability and maneuverability of vehicle, significantly in comparison with uncontrolled vehicle and Type-1 fuzzy ESC. Furthermore, we compare the conventional braking ESC with our designed ESC, i.e. distributed exertion of torque ESC and braking ESC in view point of both stabilization and performance. As we will see, proposed ESC can decrease vehicle speed reduction, in addition to better vehicle stability maintenance.

Keywords: Type-2 Fuzzy Control, Electronic Stability Control, Yaw Moment, Side Slip Angle, Torque Control

1. Introduction

Nowadays, Electric Vehicles (EVs) are receiving attention because of environmental concerns such as global warming, exhaustion of fossil fuels, and air pollution. In addition, EVs have remarkable advantages in motion control compared to internal combustion engine vehicles. Some advantages are foregoing in [19]: (1)-The response to the driving-braking force by the electric motor is about 100 times faster than engines. (2)- Development of in-wheel motors enable the individual control of each wheel. (3) The generated torque is precisely measurable from the motor current. (4) Regeneration can generate Smooth braking torque.

For widespread use of the vehicles, the next generation of them must be safe and reliable. For example, a three-axle bus rollover threshold and the effective parameters are studied in [27] in which rollover threshold is a speed that automotive is passing without occurring rollover. The objective is a

determination of the heavy vehicle rollover critical speed while turning. In addition, a multi-objective design of experimental (DOE) optimization method are developed for crash safety of a vehicle which the vehicle contains a viscoelastic body and wide tapered multi-cell energy absorber [28]. Brake system performance significantly affects safety, handling and vehicle dynamics. Hence, the researchers of reference [29] had studied a brake system design based on the method of digital logic especially for sports cars, i.e. Mercedes-AMG SLC-43.

In addition, the electronic stability control (ESC) in electric vehicles is a safety important system. By installation of heavy boxes of battery, vehicle center of gravity inadvertently moves to another position. This lead to vehicle over-steering and hence it needs additional stabilizing system such as ESC is necessary. We depicted the electric car structure in Figure (1). By this structure, we can utilize the driving and braking torques in all four wheels independently. In addition, since each of the motors directly connected to the

wheels, removes vehicle differential system for torque transmission [6].

An ESC system is an active-safety technology, which proactively help driver to maintain control of vehicle directional stability. This system continuously monitors the dynamics of the vehicle and detects the loss of control, such as over steering or under steering. After detecting instability, ESC system returns the vehicle to the desired path automatically by producing an anti-yaw moment via driving or braking torque distribution in vehicle wheels. In reference [1] an ESC control strategy is proposed based on sliding mode. In addition, a vehicle yaw controller via second-order sliding mode technique was designed that guarantee robust stability in front of disturbances and model uncertainties [2]. Based on H_∞ control theory, the reference [3] achieved to both vehicle yaw rate tracking through a single wheel brake and vehicle stability control. Reference [4], had investigated an ESC control base on fuzzy logic. An ESC control base on genetic fuzzy algorithm is developed [5] and in reference [6] ESC system based on Fuzzy PID controller are proposed. A two-surfaces sliding mode controller (TSSMC) is proposed for the voltage tracking control of a two input DC-DC converter in application of electric vehicles in [26].

Systems in which determination of exact fuzzy membership function are difficult and there are several uncertainties, Type-2 fuzzy systems has better performance vs Type-1 fuzzy systems. Unlike previous ESC designs based on Type-1 fuzzy control, the Type-2 fuzzy ESC control lead to more robustness and compensation ability of automotive systems in spite of multiple uncertainties such as vehicle weight, wheels, road, etc. Hence, we design an electronic stability control system for electric vehicles with independent torques in each wheels. This system consist of a type-2 fuzzy logic controller that realize

vehicle instability conditions, by exerting a correcting-yaw moment to restore vehicle on desired direction. In addition, we design a torque distribution algorithm for distribution of corrective torque output of the previous stage to the appropriate wheel according to vehicle situation such as oversteer and understeer and driver steering angle. In addition to the exertion of maximum yaw torque producible by vehicle, simultaneously benefits from braking and acceleration torque on both sides of the vehicle, it maintain vehicle stability, unlike conventional ESC systems that only apply braking torque to maintain vehicle stability. Briefly, this paper contribution is obtaining the state-space models for four in-wheel EV and the design of type-2 fuzzy ESP control for these type of vehicles based on both acceleration torque and braking control on both sides of vehicle.

Our paper organized as follows: Section (2) describes the vehicle model. Section (3) describes interval type-2, fuzzy mathematics. In section (4), we design ESC control system. In section (5), we will present our simulation results and finally Section (6), is conclusion and remarks.

2. VEHICLE DYNAMIC AND STATE-SPACE MODEL

ESC system design needs a simple vehicle model with important essential dynamics. Here, we use a 7-degree of freedom model from reference [15]. The lateral and longitudinal velocities of the vehicle (v_x and v_y) and the yaw rate ($\dot{\phi}$) constitute three degrees of freedom (DOF) related to the vehicle body. The velocity of four wheels constitute the other four degrees of freedoms. The equation of motion for 7-DOF model can be obtain from figure (2):

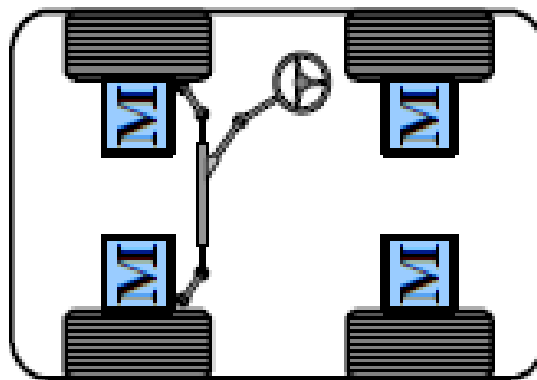

Fig1. The structure of an electric vehicle with four electric motors in the wheels [21]

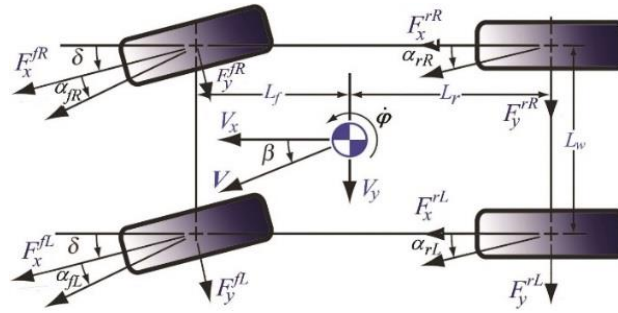

Fig2. Parameters in the 7DOF vehicle model

$$m \left(\frac{dv_x}{dt} - \frac{d\phi}{dt} v_y \right) = (F_{yf} + F_{yr}) \cos \delta - (F_{yf} + F_{yr}) \sin \delta + F_{xrl} + F_{xrr} \quad (1)$$

$$m \left(\frac{dv_y}{dt} + \frac{d\phi}{dt} v_x \right) = (F_{yf} + F_{yr}) \sin \delta + (F_{yf} + F_{yr}) \cos \delta + F_{yrl} + F_{yrr} \quad (2)$$

$$I_z \frac{d^2\phi}{dt^2} = L_f (F_{yf} + F_{yr}) \sin \delta + L_f (F_{yf} + F_{yr}) \cos \delta - L_r (F_{yrl} + F_{yrr}) + \frac{L_w}{2} (F_{yf} - F_{yr}) \cos \delta + \frac{L_w}{2} (F_{yf} - F_{yr}) \sin \delta + \frac{L_w}{2} (F_{xrr} - F_{xrl}) \quad (3)$$

Where m is the vehicle mass, Iz is the moment of inertia around z-axis, Iw is wheel base moment, Lf and Lr are the distances between vehicle center of gravity and the front and rear axles respectively. Fx and Fy are longitudinal and lateral tire forces. Four vehicle wheels are define as: front-left (fl), front-right (fr), rear-left (rl), rear-right (rr). δ is front steering angle, ϕ is vehicle yaw angle, and β is vehicle sideslip angle which is defined as:

$$\beta = \arctan \left(\frac{v_y}{v_x} \right) \quad (4)$$

Wheels rotational motion is:

$$J_w \frac{d\omega}{dt} = T_{di,j} - T_{bi,j} - F_{xi,j} r_{eff} ; (i = f, r ; j = l, r) \quad (5)$$

Here Tdi,j refer to transmitted drive torque and Tbi,j to brake torque. reff is tire effective radius, ω is the tire angular velocity and Jw is wheel inertia.

During motion, vehicle vertical load changes between front and rear axles. For instance by braking, vertical load enters on the vehicle front axle. Vertical load transfer equations on the front and rear axles are as follows:

$$F_{zf} = \frac{mgL_r \cos \theta - m a_x h_{cog} - mgh_{cog} \sin \theta}{(L_f + L_r)} \quad (6)$$

$$F_{zr} = \frac{mgL_f \cos \theta + m a_x h_{cog} + mgh_{cog} \sin \theta}{(L_f + L_r)} \quad (7)$$

hcog is height of gravity center, ax is longitudinal acceleration, θ is path slope angle, Fzf and Fzr is vertical force on the front axle and the rear axle respectively. For simulation of vehicle wheels, we use from Dugoff tire model in [10]. To obtain the state-

space model, let us define the state variables as follows:

$$\underline{X} = \begin{bmatrix} x_1 = v_x \\ x_2 = v_y \\ x_3 = \phi \\ x_4 = w_{fl} \\ x_5 = w_{fr} \\ x_6 = w_{rl} \\ x_7 = w_{rr} \end{bmatrix} \quad (8)$$

We will obtain the nonlinear state-space model as:

$$\dot{\underline{X}}(t) = \begin{bmatrix} x_3(t)x_2(t) \\ x_3(t)x_1(t) \\ \mathbf{0}_{4 \times 1} \end{bmatrix} + \underline{W}(t)\underline{F}(t) - J_w^{-1} \begin{bmatrix} \mathbf{0}_{3 \times 1} \\ \underline{T} \end{bmatrix} \quad (9)$$

In which the vectors W and F are:

$$\underline{W}(t) = \begin{bmatrix} \frac{\cos \delta}{m} & \frac{\cos \delta}{m} & \frac{1}{m} & \frac{1}{m} & \frac{\sin \delta}{m} & 0 \\ \frac{\sin \delta}{m} & \frac{\sin \delta}{m} & 0 & 0 & \frac{\cos \delta}{m} & \frac{1}{m} \\ L_f \sin \delta - \frac{L_w \cos \delta}{2} & L_f \sin \delta + \frac{L_w \cos \delta}{2} & \frac{L_w}{2I_z} & \frac{L_w}{2I_z} & \frac{L_f \cos \delta}{I_z} & \frac{L_r}{I_z} \\ -\frac{r_{eff}}{J_w} & 0 & 0 & 0 & 0 & 0 \\ 0 & -\frac{r_{eff}}{J_w} & 0 & 0 & 0 & 0 \\ 0 & 0 & -\frac{r_{eff}}{J_w} & 0 & 0 & 0 \\ 0 & 0 & 0 & -\frac{r_{eff}}{J_w} & 0 & 0 \end{bmatrix}$$

$$\underline{F}(t) = [F_{yf} \ F_{yr} \ F_{xrr} \ F_{xrl} \ F_{yf} \ F_{yr}]^T, \underline{T} = [T_{fr} \ T_{fl} \ T_{rr} \ T_{rl}]^T$$

In this equation, the control signal is the torque and forces. To calculate the equilibrium point of a nonlinear system, both the control signal and state derivative must set to zero, hence $\underline{F}(t) = [0]_{6 \times 1}, \underline{T} = [0]_{4 \times 1}$ and $\dot{\underline{X}}_E = [0]_{7 \times 1}$ which E-index is the Equilibrium. Then the equilibrium of above equations is $x_{3E} = \dot{\phi}_E = 0$ means that vehicle has not yaw rate. Hence, the equilibrium point stability of this system means keeping vehicle yaw rate at zero.

Physically it means that ESC control effort should maintain the vehicle in every yaw direction exerts by driver. This viewpoint may not explain in many

3. Fuzzy Set and Systems

4. Type1 Fuzzy Sets

Type-1 fuzzy sets (T1FSs) were originally introduced by Zadeh in 1965 [7]. The successful applications of type-1 fuzzy logic controllers (T1FLCs) had reported in many researches. For example, in control and modeling, predictions of time series and other applications [23-24]. Despite the apparent advantages of T1FSs, it had shown that it is not able to handle the effect of uncertainties completely [25]. This is because a T1FS is certain in the sense that its membership grades are crisp values.

In the real world, many of uncertainty exist in the face of fuzzy system such as: (1)-Describing parts of the fuzzy rules are uncertain, that is mean the words used in the parts of antecedent and consequent of laws can have different meanings for different people. (2)-The results obtained of the group of experts often for the law will be different because experts are not necessarily in agreement with each other. (3)-Measurements that activates a fuzzy system may be Noisy and therefore are uncertain. Thus, there is often some uncertainty related to the data.

research papers of vehicle ESC stability since the ultimate goal of ESC control system is the control of yaw angle, for example in this era see [4, 5, 20].

To overcome this uncertainty, type-2 fuzzy sets (T2FSs) were introduced by Zadeh as an extension of T1FSs (Zadeh, 1975) [8]. T2FSs have membership functions that are fuzzy themselves while T1FSs have certain membership functions. In the other hand, the membership grade of type-1 membership functions are crisp numbers, whereas the membership degree of type-2 membership functions can be any subset in the interval [0, 1] that are called primary membership function (PMF). In addition, according to any PMF, a value that called secondary membership function (SMF) that defines the probability of PMFs.

Since this improvement increases the computational burden, interval type-2 fuzzy logic controllers (IT2FLCs) in which SMFs are zero or one, are developed [9].

IT2FSs as a special case of T2FSs, are currently the most widely used to reduce computational burden. Figure (3) illustrates an example of IT2FS. According to this figure, the membership degree of each element of x in the domain of IT2FS is an interval. For example, as we see in Figure (3), the membership degree of 0.65 is an interval between [0.2, 0.7]. IT2FSs are bounded from up and down with two T1FMs that are called upper membership function (UMF) and lower membership function (LMF). The area between UMF and LMF is footprint of uncertainty (FOU).

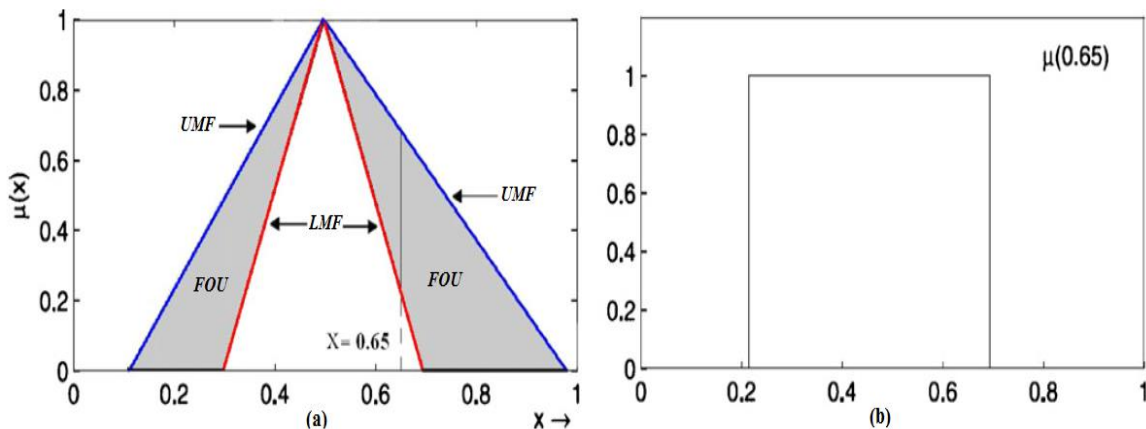

Fig3. (a) Interval type-2 fuzzy set and (b) secondary MF at $x=0.65$ [16]

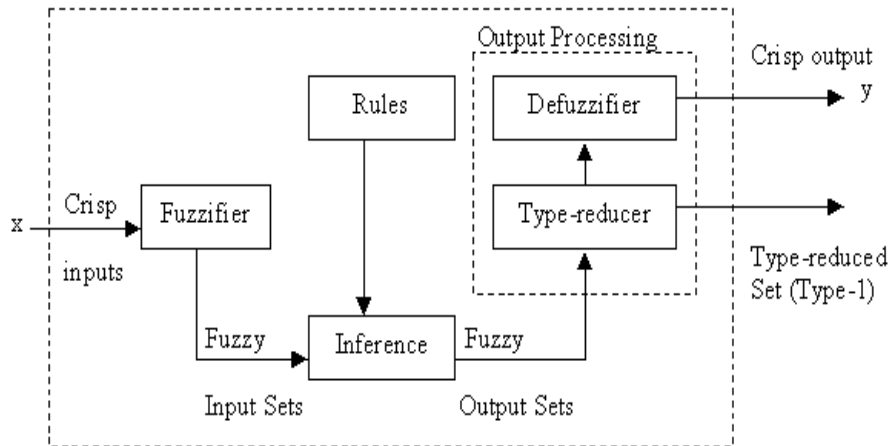

Fig4. Structure of type-2 fuzzy logic system [9]

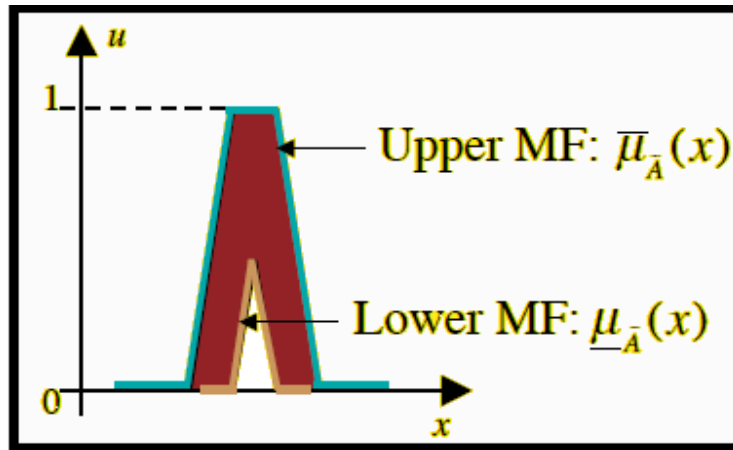

Fig5. Upper MF and Lower MF [16]

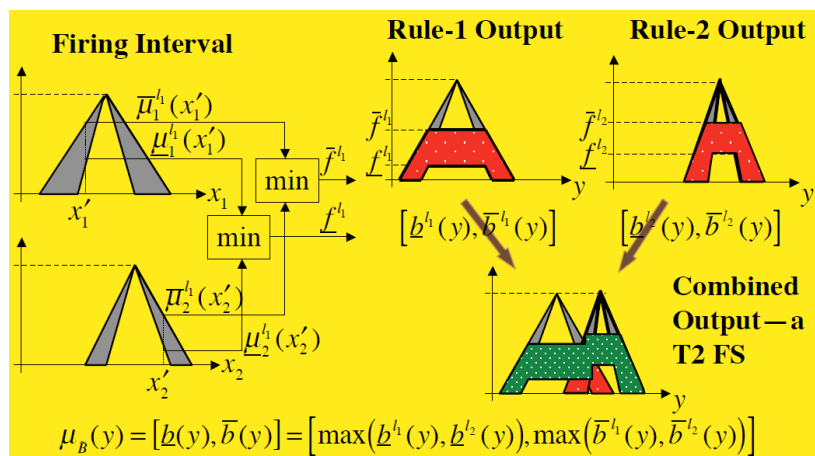

Fig6.. Levels of calculation for type-2 fuzzy system [16]

5. Interval Type-2 Fuzzy Logic

A type-2 FL System includes four stage: (a)-type-2 fuzzyfier, (b)-rule-base, (c)-inference engine and (d)-output processor. The output processor includes a type-reducer and defuzzyfier. Comparing to type-1 fuzzy system, the main difference is the type reducer part which it converts the type-2 fuzzy set into the type-1 fuzzy set. Finally, in defuzzyfier part, type reduced set convert to a crisp number. Figure (4) depicts the structure of type-2 fuzzy logic system.

An interval type-2 fuzzy set A can be characterize as:

$$A = \left\{ \left((x, u), u_A(x, u) = 1 \right) \mid \forall x \in X, \forall u \in J_x \subseteq [0, 1] \right\} \tag{10}$$

Where x is the primary variable and its measurement domain denoted by X ; u is the secondary domain variable $u \in J_x$ at each $x \in X$, J_x is the primary membership of x . The amplitude of the secondary MF is the "secondary grade." For an interval type-2 fuzzy set, the secondary grade equals 1 over the entire of FOU, $u_A(x, u) = 1$; hence, the new third dimension of a type-2 fuzzy set does not convey any new information for an interval type-2 fuzzy set. So uncertainties in an interval type-2 fuzzy set characterizes by FOU completely. Membership function of interval type-2 fuzzy set is:

$$u_A(x) = \int_{u \in J_x} \frac{1}{u} = [u_A(x), \bar{u}_A(x)] \quad x \in X \tag{11}$$

IT2 FS is bounded from the above and below by two T1 FSs, $\bar{u}_A(x)$ and $u_A(x)$, which are upper MF (UMF) and lower MF (LMF), respectively. The area between $\bar{u}_A(x)$ and $u_A(x)$ is the footprint of uncertainty (FOU).

Math operation of IT2FL is almost similar to T1FL and the only differences is in input and output membership functions and output processor. However, in other parts, such as fuzzifier, rule-base and inference engine is similar to T1FL. Mathematically, instead of computing an area of type-1 rule output FS, the T2FLSs compute two such FSs for each fired rule, one for the LMF and one for the UMF of the fired rule-output fuzzy sets. Again, each of these two calculations only involves type-1 FS calculations. Figure (6) shows the levels of calculations to reach to output of type-2 fuzzy system for a two-fired rules system with two input-one output.

Type-2 fuzzy system Output is a type-2 fuzzy set. While we need a crisp number in output, to reach this

goal, we must convert the first type-2 fuzzy output in type reducer block to a type-1 fuzzy set and then by using defuzzification methods in T1FL convert it to a crisp number.

Type reduction in IT2 FLSs is the most intensive operation. There are several methods for computing type-reduction. Some methods have high precision but leads to large computational costs and others have lower computational cost but have less accurate. In this article, we use the Karnik- Mendel (KM) algorithm [11].

The KM algorithm converges monotonically and super-exponentially fast. In this paper, for type-reduction from the center-of-sets method, we use the method of [9]:

$$Y_{Cos}(x) = \bigcup_{\substack{f^n \in F^n(x) \\ y^n \in Y^n}} \left(\frac{\sum_{n=1}^N f^n y^n}{\sum_{n=1}^N f^n} \right) = [y_l, y_r] \tag{12}$$

Where Y_{Cos} is an interval type-1 fuzzy set determined by its two end points y_l and y_r . that y_l and y_r is Minimum and maximum this distance respectively. This values can be computed efficiently using the Karnik-Mendel (KM) algorithms as follows [9],[18]:

$$y_l = \frac{\sum_{n=1}^L \bar{f}^n y^n + \sum_{n=L+1}^N f^n y^n}{\sum_{n=1}^L \bar{f}^n + \sum_{n=L+1}^N f^n}, y_r = \frac{\sum_{n=1}^R f^n \bar{y}^n + \sum_{n=R+1}^N \bar{f}^n \bar{y}^n}{\sum_{n=1}^R f^n + \sum_{n=R+1}^N \bar{f}^n} \tag{13}$$

In above equations, \bar{f}^n and f^n are upper and lower firing interval for each output rule and \bar{y}^n and y^n are upper and lower membership function center in the consequent part respectively.

The main idea of the KM algorithm is to find the switch points L and R for y_l and y_r to ensure from their minimum and maximum. The switch point L and R in KM algorithm is determined by following equation.

$$\begin{aligned} y_l^L &\leq y_l \leq y_l^{L+1} \\ \bar{y}^R &\leq y_r \leq \bar{y}^{R+1} \end{aligned} \tag{14}$$

Take y_l for example. y_l is the minimum of $Y_{Cos}(x)$.

Since y^n increases from the left to the right along the horizontal axis of Figure (7), we should choose a large weight (upper membership grade \bar{f}^n) for y^n on the left of switch point L and a small weight (lower membership grade f^n) for y^n on the right of switch point L . The KM algorithm finds the switch point L . For $n \leq L$, the upper membership grades are used to

calculate y_l ; for $n > L$, the lower membership grades are used. This will ensure y_l be the minimum.

After calculating y_l and y_r , must compute the defuzzified (crisp) output as follows:

$$y = \frac{y_l + y_r}{2} \tag{15}$$

According to being new the type-2 fuzzy logic, few specialized tools designed for the use of type-2 fuzzy sets, among these tools can be mentioned to graphics toolbox that designed by Taskin et al., [12]. This toolbox has the same environment with type-1 fuzzy graphics toolbox in MATLAB. In simulation section, we will use this toolbox for designing IT2FC.

6. ESC Control System Design.

ESC system is a vehicle safety active control system. It improves vehicle's lateral stability in emergencies. Two instances of vehicle directional instability may occur as follows:

Oversteer: the actual path followed by the vehicle moves in towards the center of the curvature of turn with respect to the driver's intended desired path. In other words, the vehicle start 'spinning'. In over-steer situation, vehicle has higher yaw rate and larger sideslip angle.

Understeer: when vehicle is turning, due to slip at the front axle, it deviates away from the driver's intended path. An under-steer vehicle can be characterized by less yaw rate and smaller side-slip angle.

Both above conditions are undesirable and it is due to loss of driver control on vehicle, lead to probability incensement of an accident. Controller should apply a corrective yaw moment in opposite direction to the driver generated yaw moment to overcome this situation To create yaw moment on vehicle is equivalent to generate positive or negative torque on a specific wheel. To check the yaw rate of vehicle stability, control system must apply $d\phi / dt$ and sideslip angle (B). Then, the error between them and desirable values are inputs of fuzzy controller. Since, desired values had obtained by normal yaw rate and sideslip angle, then we expect guide angles and different conditions such as turning and double lane change maneuver, without vehicle control lose.

Figure (9) shows the overall structure of the ESC controller. This controller includes two layers: The first layer contains a fuzzy controller for calculating the correction torque and the second layer consists of a torque distributor to allocate torque generated by first layer to appropriate wheels. In this control structure, by comparing yaw rate and sideslip angle with desirable values (which is obtained from reference model) to determine error rate as ESC controller input. In addition, the required corrective yaw moment (M_z) is controller output. Then, the negative or positive torque will distribute by distributor block on electric motors mounted in each wheel.

When the vehicle moves as expected, the smaller sideslip angle is better. On vehicle dynamics researches, the desired sideslip is generally considered as 0 degree, i.e., $B_{des}=0$.

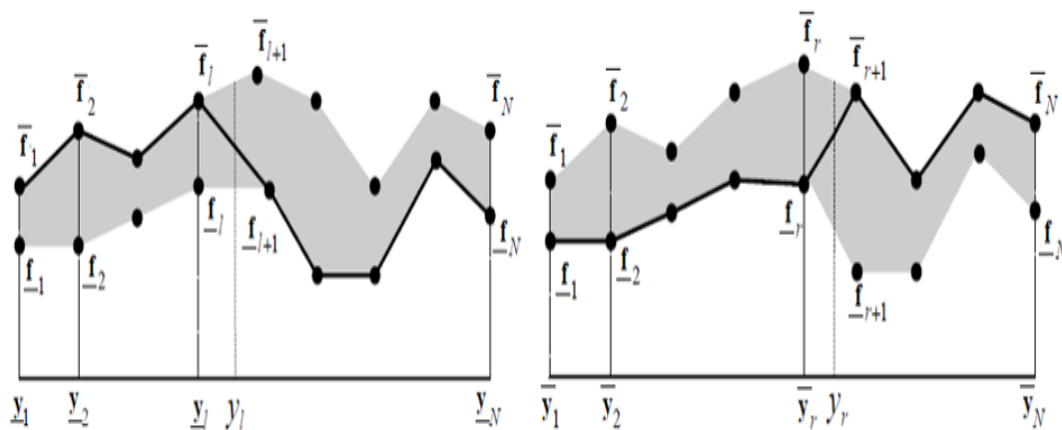

Fig7.Switch point in KM algorithm [17]

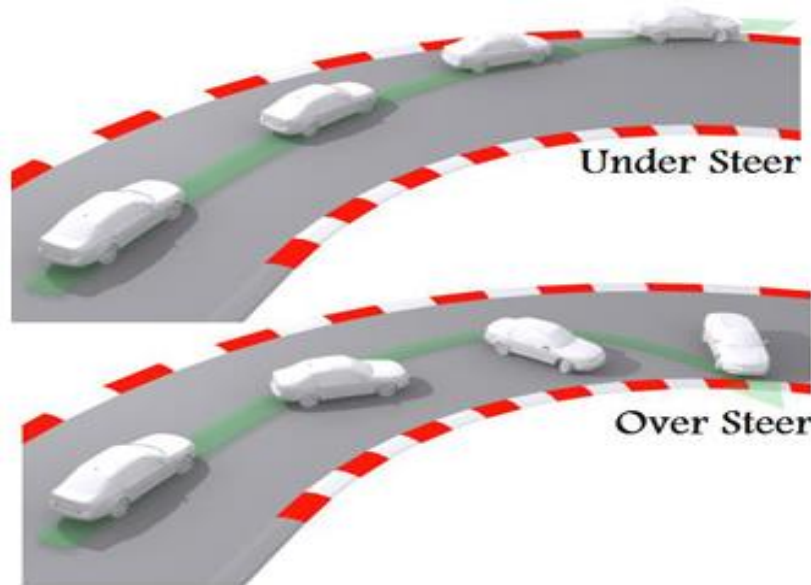

Fig8. Under-steer and Over-steer in vehicle

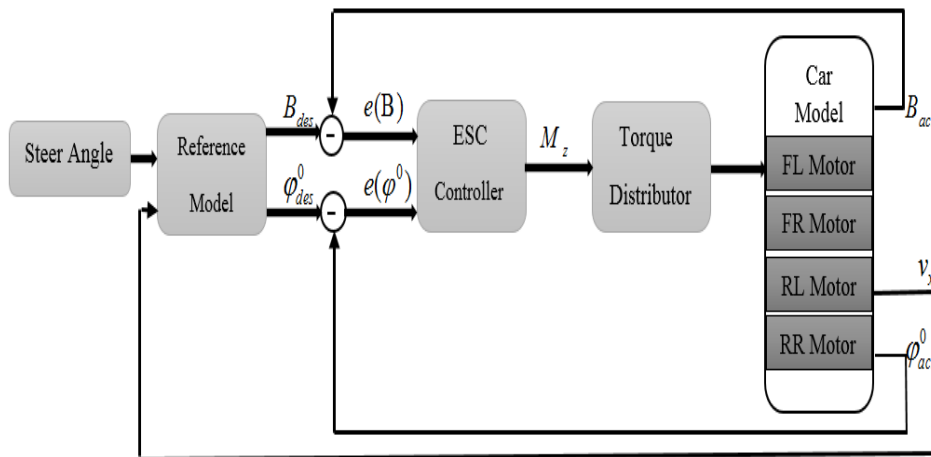

Fig9.. Overall structure of our ESC control system

7. Linear 2-DOF Reference Model

The vehicle desired yaw rate from a simplified 2DOF linear model are as follows [13]:

$$\frac{d\phi_s}{dt} = \frac{V \cdot \tan \delta}{L \left(1 + \left(\frac{V}{V_{ch}} \right)^2 \right)}, \quad V_{ch}^2 = \frac{C_{af} C_{ar} L^2}{m(C_{ar} L_r - C_{af} L_f)} \quad (16)$$

which C_{af} and C_{ar} are side stiffness of front and rear axle. The normal yaw rate calculate from (16) may exceeds the max yaw rate that is limited by road

adhesion. The max normal yaw rate should be calculate from the following equation:

$$\frac{d\phi}{dt} = \pm \frac{\mu g}{V_x} \quad (17)$$

μ is the tire-road friction coefficient and g is the earth gravitational acceleration. If the value calculated from equation (16) exceeds the value from equation (17), the max value of the normal yaw rate is the latter.

8. Type-2 Fuzzy ESC Design

The main objective of ESC system is to reduce the yaw rate error and sideslip error by creating a

corrective yaw moment, until to maintain the vehicle desired stability. Type-2 fuzzy ESC controller has two inputs consisting of yaw rate error $e(\dot{\varphi}) = \dot{\varphi}_{des} - \dot{\varphi}_{act}$ and sideslip angle error $e(B) = B_{des} - B_{act}$ and Procedure for forming fuzzy control rules and also torque distribution layer is as follows [20]:

The first mode: to occur under-steer mode when the vehicle suddenly turn to the left. This mode characterized by $e(\dot{\varphi}) > 0$ and $e(B) < 0$. To control this situation, the fuzzy controller must generate negative yaw moment in the counterclockwise direction. Then in the torque distributor block, this torque distribute in the form of rear-right wheel accelerating and rear-left wheel braking.

The second mode: to occur over-steer mode when the vehicle suddenly turn to left. This mode characterized by $e(\dot{\varphi}) < 0$ and $e(B) > 0$. To control it, fuzzy controller must generate positive yaw moment in the clockwise direction. Then in the torque distributor block, this torque distribute in the form of front-right wheel braking and front-left wheel accelerating.

The third mode: to occur under-steer mode when the vehicle suddenly turn to right. This mode characterized by $e(\dot{\varphi}) < 0$ and $e(B) > 0$. To control it, fuzzy controller must generate positive yaw moment in the clockwise direction. Then in the torque distributor block, this torque distribute in the form of rear-right wheel braking and rear-left wheel accelerating.

The fourth mode: to occur under-steer mode when the vehicle suddenly turn to right. This mode characterized by $e(\dot{\varphi}) > 0$ and $e(B) < 0$. To control it, fuzzy controller must generate negative yaw moment in the counterclockwise direction. Then in the torque distributor block, this torque distribute in the form of front-right wheel accelerating and front-left wheel braking.

The ESC controller performance for the four mentioned modes illustrated in figure (12).

controller output is corrective yaw moment M_z . To provide enough rule coverage for fuzzy controller, we consider five fuzzy sets for each of the yaw rate and sideslip error variables with linguistic variables {NB,

NS, ZE, PS, PB}. In addition, seven fuzzy sets describe the controller output by linguistic variables {NB, NM, NS, ZE, PS, PM, PB}. These symbols are acronym of Negative Big (NB), Negative Medium (NM), Negative Small (NS), Zero (ZE), Positive Small (PS), Positive Medium (PM), Positive Big (PB). According to some practical tests, the maximum allowable sideslip angle error and yaw rate error when driving through a severe double-lane-change maneuver are assumed to be 100 and 350/s, respectively[14], which correspond well with the limits found in the literature for normal passenger cars. Based on this practical information range of input variables are: sideslip angle error in $[-0.2, 0.2] rad$ and for yaw rate error $[-0.6, 0.6] (rad/sec)$. Moreover, maximum possible torque due to in-wheel motors is 400 N/m. So the range of change corrective yaw moment M_z is considered to be in interval $[-400, 400]$. The membership function input and output variables is shown in figure (10), also the fuzzy controller schematic in MATLAB Simulink environment is shown in figure (11).

In IT2FL we will use the Sugeno fuzzy inference engine, minimum for AND, maximum for OR, minimum for implication, maximum for aggregation and finally for type reduction and defuzzification the KM algorithm. We report the rule based fuzzy controller in table (1).

After corrective yaw torque calculation by fuzzy controller in first layer, it distributes to wheel motors. Torque distributor does this task. Torque distributor identify vehicle situations such as over-steering, under-steering, steer angle drive, sign of M_z and etc. based on this information, it will distributes appropriate torque to respective wheels. In torque distribution to acquire maximum possible yaw moment, we will exert the negative torque to wheels of one side and the positive torque to cross-wheel of the other side. In fact, after assignment of corrective torque to a wheel for braking or acceleration, reverse of this torque assigns to cross-wheel on the other side. Furthermore, to make torque that is more effective in under-steering situation due to front axle slip, the system must distributes torque only to rear axle. Similarly, in over-steering situation due to rear axle slip, the torque distributed only to the front axle. Table (2) reports the wheels torque allocation.

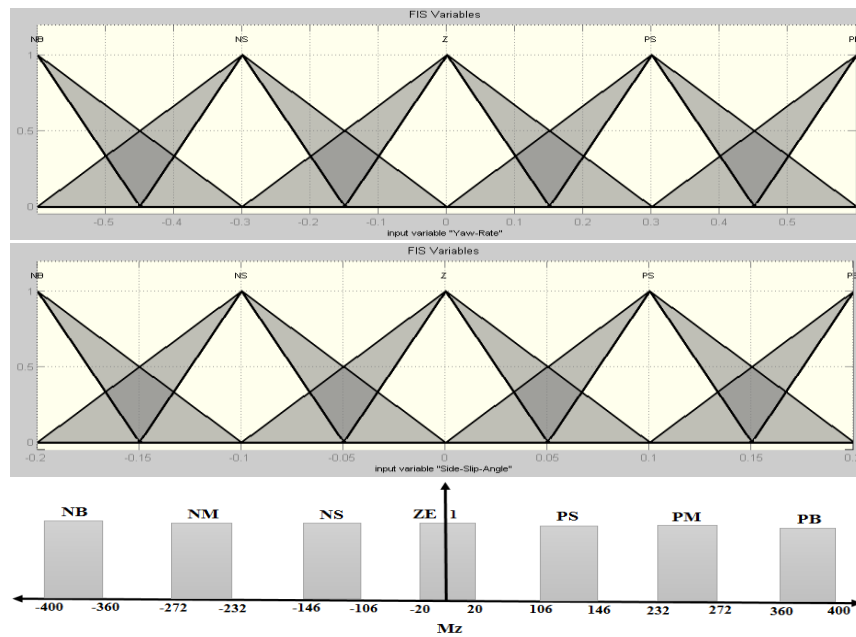

Fig10. Our Interval type-2 membership functions of inputs and output variables

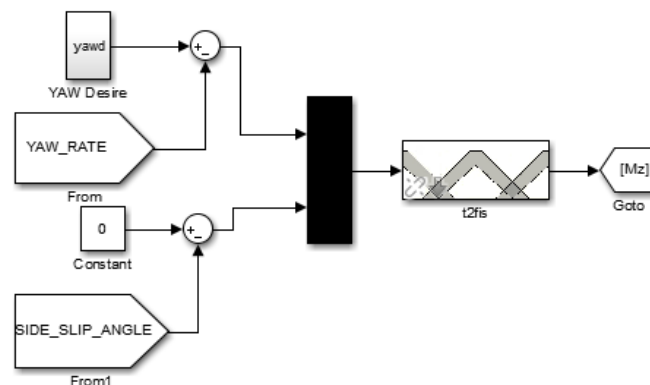

Fig11. Fuzzy controller schematic in our MATLAB Simulink environment

Table 1. Rule base the fuzzy controller

Rule Base		e (B)				
		NB	NS	ZE	PS	PB
$e(\varphi^0)$	NB	ZE	PS	PM	PB	PB
	NS	ZE	ZE	PS	PM	PB
	ZE	NM	NS	ZE	PS	PM
	PS	NB	NM	NS	ZE	ZE
	PB	NB	NB	NM	NS	ZE

Table 2 : Allocation torque table to the wheels

	$e(B) < 0$	$e(\varphi^0) > 0$	$\delta > 0$	$M_z < 0$	Under-Steer	RL Braking RR Accelerating
	$e(B) > 0$	$e(\varphi^0) < 0$	$\delta > 0$	$M_z > 0$	Over-Steer	FR Braking FL Accelerating
	$e(B) > 0$	$e(\varphi^0) < 0$	$\delta < 0$	$M_z > 0$	Under-Steer	RR Braking RL Accelerating
	$e(B) < 0$	$e(\varphi^0) > 0$	$\delta < 0$	$M_z < 0$	Over-Steer	FL Braking FR Accelerating

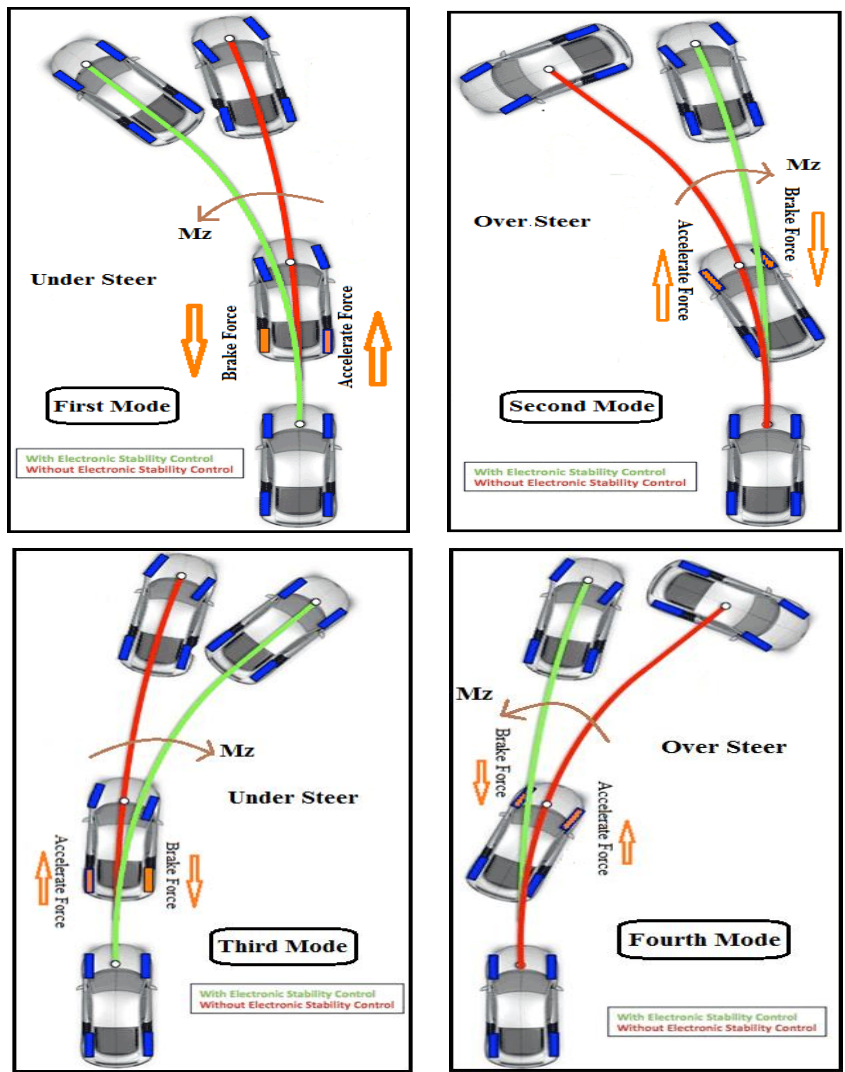

Fig12. The ESC controller performance in different models [22]

Table 3. Vehicle Specifications

Parameter	Value	Parameter	Value
Total weight	600 kg	Distance from COG to front axle L_f	1.18 m
Height of gravity center h_{cog}	0.7 m	Distance from COG to rear axle L_r	1.77 m
Moment of inertia I_z	1800 kg.m^2	Wheel base L_W	1.5 m
Wheel inertia J_W	1.26 kg.m^2	Tire effective radius r_{eff}	0.302 m
Maximum motor power	10.7 KW	Maximum motor torque	400 Nm

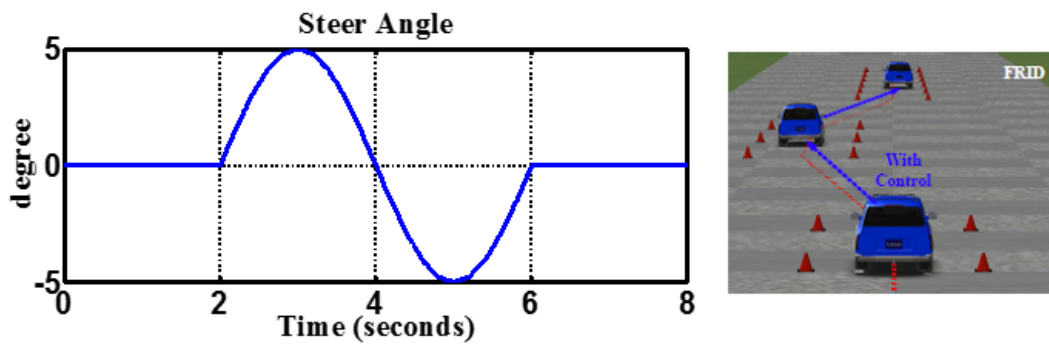
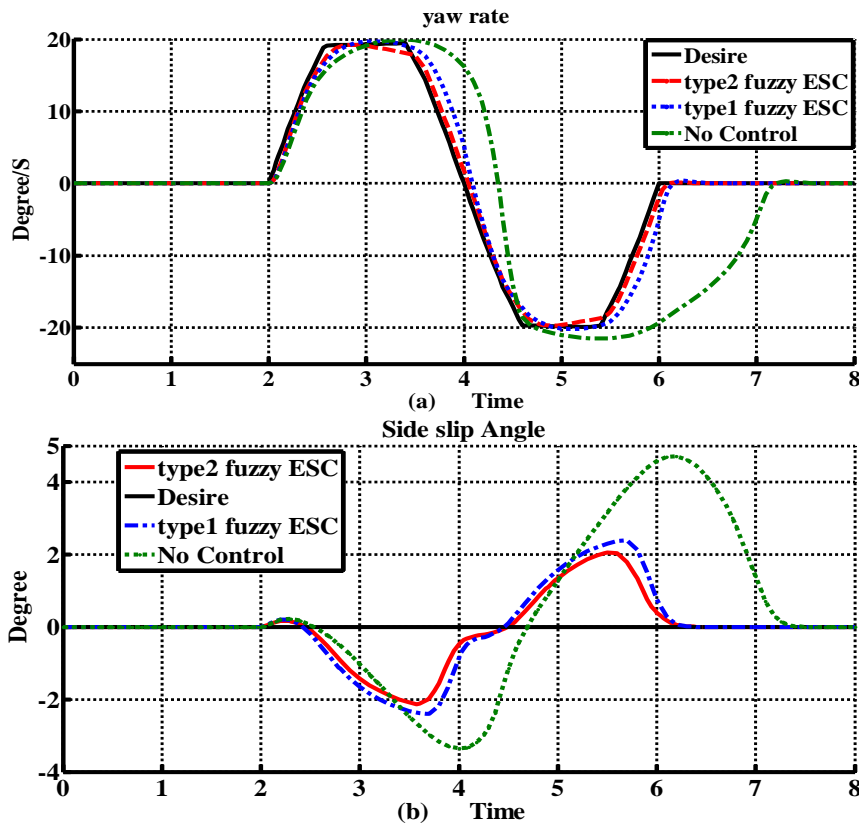

Fig13. The path of the car and the car steer angle



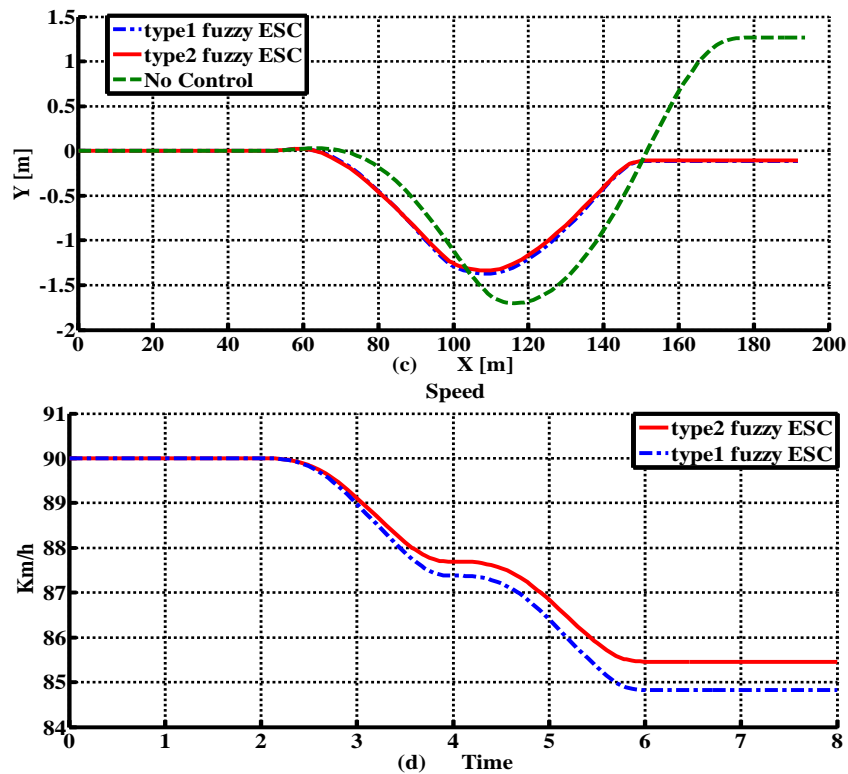

Fig14. (a) response of yaw rate. (b) Response of side slip angle. (c) Displacement of vehicle in the coordinate plane. (d) Changes of vehicle speed

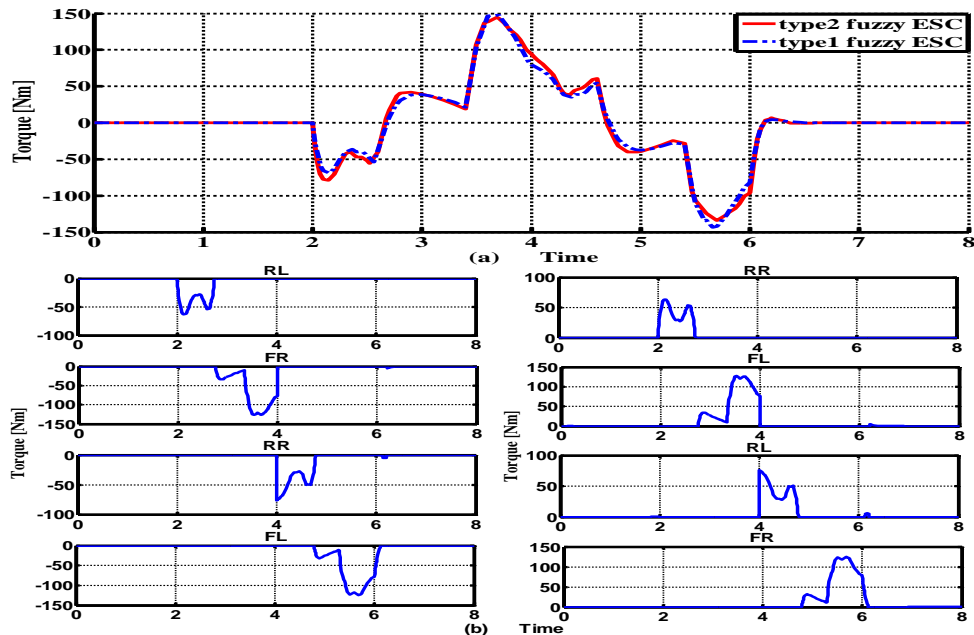

Fig15. (a) Corrective yaw moment output of the fuzzy controller. (b) Output torque distribution of IT2FL controller to in-wheel motors

9. Simulation and Analysis

10. Double Lane Change Maneuver

Performance of ESC control system evaluate with a double lane change maneuver that in this test. The vehicle parameters in this paper is reported in table 3.

For simulation vehicle runs at constant speed of 90 km/h in the dry road with friction coefficient $\mu = 0.8$. Figure (13) depicts the steering wheel input at double lane change. The responses of vehicle with interval type-2 fuzzy ESC control are compared to type-1 fuzzy ESC control with the same rules and membership functions and with without control. The test results are in Figures 14-15.

The results show that the vehicle can track desired yaw rate and keeps sideslip angle within stable range, and driver can control the vehicle. In addition, the response of vehicle with IT2FL ESC control and T1FL ESC control can track the ideal output of the reference model compared to without ESC control. However, in comparison with T1FL ESC control, the vehicle with IT2FL ESC control has better performance and stability

11. The effect of ESC controller on a low friction road surface

In this section, we evaluate the performance of ESC control system with a double lane change maneuver in snowy road with friction coefficient of $\mu = 0.3$. Driving conditions and vehicle steer angle is like the previous section. Figure (16) depicts the test results and Table (4) reports the numerical comparison of experiments.

The test result imply that in double lane change maneuver in snowy road, the vehicle without ESC

system completely lose control. The vehicle with ESC system can track desired yaw rate and keeps sideslip angle within stable range. Hence, driver can control the vehicle.

12. Step steering test

Step steering experiment adopted to validate the performance of ESC controller. In this cornering test, the vehicle runs at constant speed of 90 km/h in snowy road with friction coefficient $\mu = 0.3$, and the driver input steering wheel angle is 20 degrees. We will compare the responses of vehicle with interval type-2 fuzzy ESC control to system without any control and type-1 fuzzy ESC control with same rules and membership functions.

After sudden change in steering, the vehicle get an oversteering in the counterclockwise direction and vehicle goes out of the way in an uncontrolled manner. Now to restore the car to the desire direction, fuzzy controller must generate positive yaw moment in the clockwise direction. Then in the torque distributor block, this torque distribute in the form of front-right wheel braking and front-left wheel accelerating as shown that in figure(18).

We can see in figure (17) that the yaw velocity and sideslip angle convergence rapidly. The yaw velocity of ESC control system can also track the 2dof ideal reference model closely.

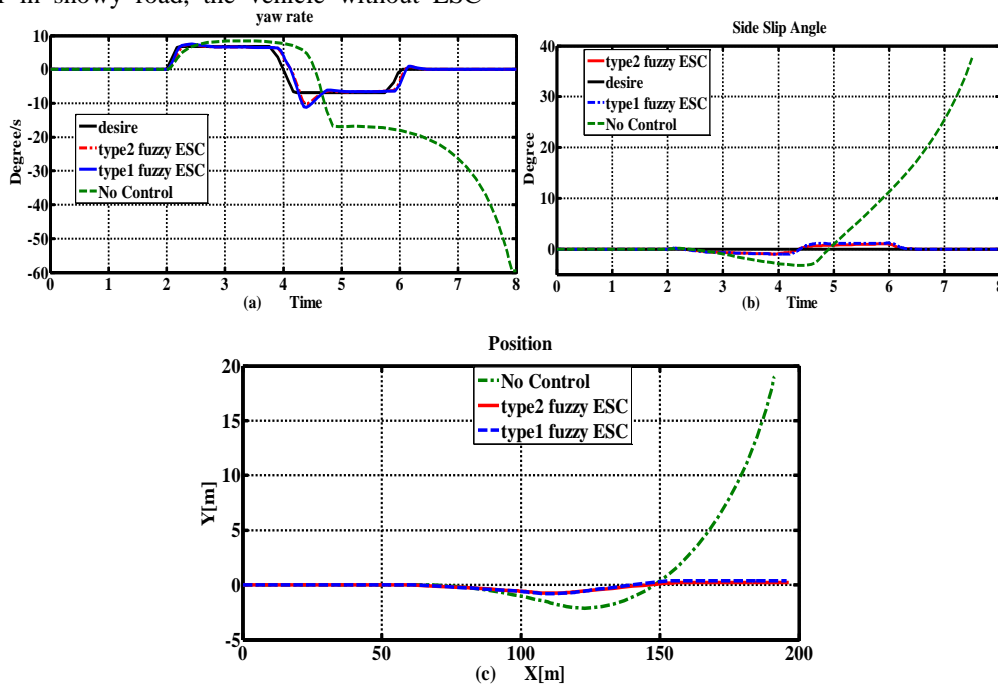

Fig16. (a) response of yaw rate. (b) Response of side slip angle. (c) Displacement of vehicle in the coordinate plane

Table 4. Quantitative comparison among type2 and type1 fuzzy ESC and without control in double lane change maneuver on (Intel Core i5, 2.5 GHZ)

$\mu = 0.8$	Mean Square Error (MSE)	Without Controller	Type2 fuzzy ESC	Type1 fuzzy ESC
	Yaw rate-MSE ($\varphi_{act}^\circ - \varphi_{des}^\circ$)	46.23	0.6633	2.6695
	Side slip angle-MSE ($B_{act} - B_{des}$)	3.7501	0.5986	0.8480
$\mu = 0.3$	Mean Square Error (MSE)	Without Controller	Type2 fuzzy ESC	Type1 fuzzy ESC
	Yaw rate-MSE ($\varphi_{act}^\circ - \varphi_{des}^\circ$)	259.07	1.8093	4.4280
	Side slip angle-MSE ($B_{act} - B_{des}$)	247.06	0.2080	0.3216
Run Time Simulation (second)			0.056	0.045

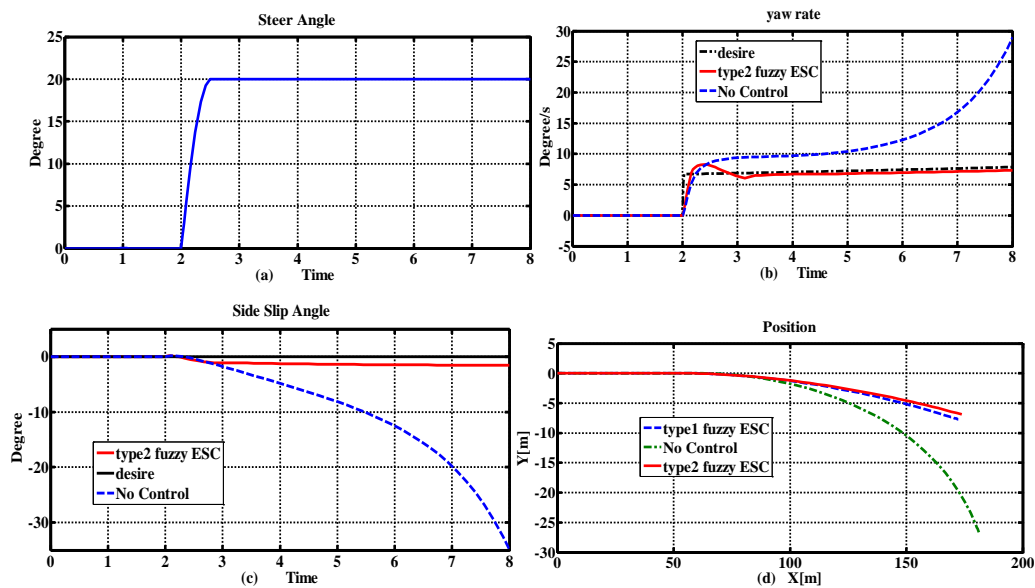

Fig17. (a) vehicle steer angle. (b) Response of yaw rate. (c) Vehicle sideslip angle. (d) Displacement of vehicle in the coordinate plant

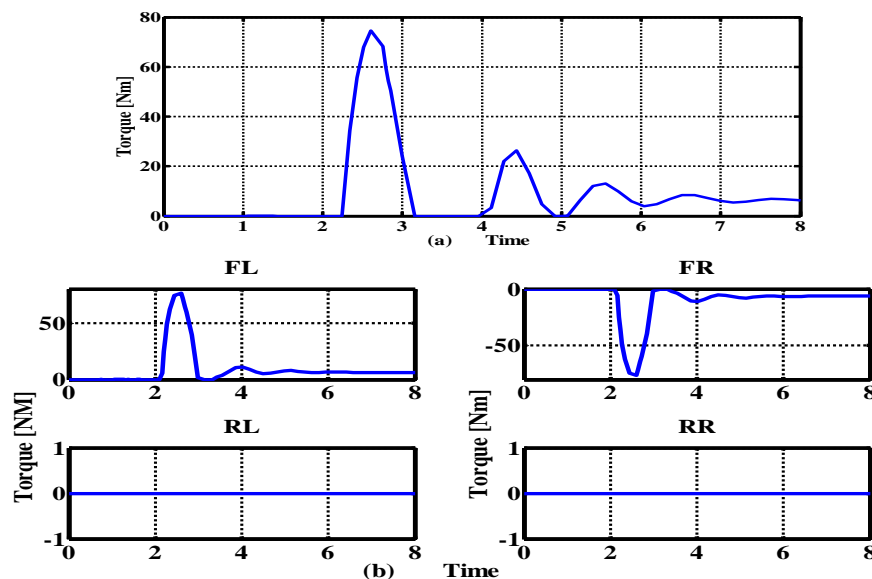

Fig18. (a) Corrective yaw moment output of the fuzzy controller. (b) Output torque distribution of IT2FL controller to in-wheel motors

Table 5. Quantitative comparison among type2 and type1 fuzzy ESC and without control in step steering test on (Intel Core i5, 2.5 GHZ)

Mean Square Error (MSE)	Without Controller	Type2 fuzzy ESC	Type1 fuzzy ESC
Yaw rate-MSE ($\varphi_{act}^{\circ} - \varphi_{des}^{\circ}$)	19.6606	0.8057	1.1067
Side slip angle-MSE ($B_{act} - B_{des}$)	89.096	0.5108	0.74
Run Time Simulation (second)		0.056	0.045

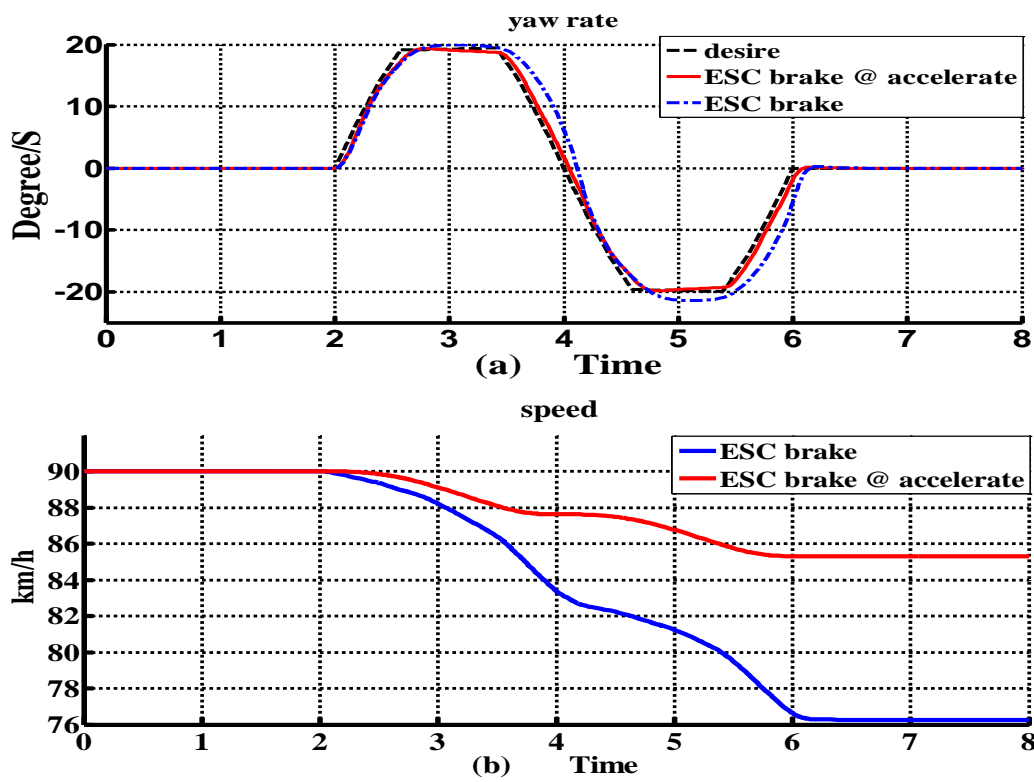

Fig19. (a) Response of yaw rate and (b) changes of vehicle speed

Table 6. Quantitative Comparison between Designed ESC and Conventional ESC

Mean Square Error (MSE)	ESC with braking and acceleration	ESC with only braking
Yaw rate-MSE ($\varphi_{act}^{\circ} - \varphi_{des}^{\circ}$)	0.4355	2.1214

13. Comparison between our New Designed ESC and Conventional ESC

In conventional ESC, which only use braking torque to make corrective yaw moment, in non-emergency situations due to braking intervention at work driver, lead to further reduction of vehicle speed. This type of ESC beget an unpleasant feeling in the driver. However, in ESC system that designed in this article, due to simultaneous exertion of braking and accelerating torque, reduce vehicle speed less. Meanwhile, in emergencies, vehicle stability well maintained. Figure (19) depicts the comparison of speed and yaw rate between ESC designed in this article and ESC that use only braking torque with the same fuzzy controller in a double lane change test with the same specification

14. Conclusion

In this work an Electronic Stability Control system based on type-2 fuzzy logic theory for electric vehicles with independent torque at each wheel for tracking desired vehicle behavior is developed. The proposed controller improved handling and stability of the vehicle by controlling the parameters yaw rate and sideslip angle of vehicle. The results show that the proposed system clearly improves the vehicle stability compared with the uncontrolled vehicle, and has a better performance compared with type-1 fuzzy controller. However, according to table(4), yaw rate error and side slip error from their optimal value in type2 fuzzy controller is better than type1 fuzzy controller and type2 fuzzy ESC control system can also track the 2dof ideal reference model closely. However, because of more computational complexity, run time simulation in

It also uses a torque distributor that use braking and accelerating on both sides of the vehicle, which cause Reduce vehicle speed less than ESC control system that use only intervention braking to maintain vehicle stability and yaw rate error in designed controller is less.

References

- [1]. LiQiang Jin and Yue Liu, "Study on Adaptive Slid Mode Controller for Improving Handling Stability of Motorized Electric Vehicles," IEEE. 1-4244-1259 -2014
- [2]. Massimo Canale, Lorenzo Fagiano, "Vehicle Yaw Control via Second-Order Sliding-Mode Technique. IEEE Transaction on Industrial Electronic," VOL. 55, NO. 11-2008.
- [3]. Jong Hyeon P, Woo Sung A, "H ∞ yaw 2 moment control with brakes for imp roving driving performance and stability," [C] USA, 1999, 9: 7472752.
- [4]. Li, Bin, Daofei Li., and Fan Yu, "Vehicle Yaw Stability Control Using the Fuzzy-Logic Controller," IEEE. 1-4244-1266.2007.
- [5]. Kiumars Jalili, "Stability Control of Electric Vehicles With In-Wheel Motors," Doctoral thesis, University of Waterloo, Ontario, Canada 2010.
- [6]. Li Zhai, Tianmin Sun and Jie Wang, "Electronic Stability Control Based on Motor Driving and Braking Torque Distribution for a Four In-Wheel Motor Drive Electric Vehicle," IEEE DOI 10.1109/TVT.2016.2526663.
- [7]. L. A. Zadeh, ". Fuzzy sets. Information and control," 8(3), 338–353. 1965.
- [8]. L. A. Zadeh, "The Concept of a Linguistic Variable and Its Application to Approximate Reasoning—I. Information Sciences," Vol. 8, pp. 199-249, 1975.
- [9]. Mendel, J. M, "Uncertain rule-based fuzzy logic system: Introduction and new directions," Upper Saddle River, NJ: Prentice Hall. 2001.
- [10]. Dugoff, H., Fancher, P.S. and Segal, L, "Tire performance characteristics affecting vehicle response to steering and braking control inputs," Final Report, Contract CST-460, Office of Vehicle Systems Research, US National Bureau of Standards, 1969.
- [11]. J. M. Mendel, "On a 50% Savings in The Computation of The Centroid of a symmetrical Interval Type-2 Fuzzy Set," Information Sciences, Vol. 172, pp. 417-430, 2005.
- [12]. Ahmet Taskin, Tufan Kumbasar, "Digital single sideband detection for interferometric sensors," An Open Source Matlab/Simulink Toolbox for Interval Type-2 Fuzzy Logic Systems-2015.
- [13]. Hongwen He, Jiankun Peng, Rui Xiong and Hao Fan, "An Acceleration Slip Regulation Strategy for Four-Wheel Drive Electric Vehicles Based on Sliding Mode Control," Energies 2014, 7, 3748-3763; doi:10.3390/en7063748

- [14]. Kiencke, U. and Nielsen, L, "Automotive Control Systems for Engine, Driveline, and Vehicle," 2nd edition, Springer, 2005.
- [15]. Rajesh Rajamani, "vehicle dynamics and control," Springer Science and Business Media Inc, pp221-556, 2006.
- [16]. Jerry M. Mendel, "Why Type-2 Fuzzy Sets Should be Used and How They Can be Used," University of Southern California Los Angeles, CA 90089-2564; 2004.
- [17]. D. Wu and M. Nie, "Comparison and practical implementation of type-reduction algorithms for type-2 fuzzy sets and systems. In Proc," IEEE Int'l Conf. on Fuzzy Systems, Taipei, Taiwan, June 2011.
- [18]. J. M. Mendel and D. Wu, "Perceptual Computing: Aiding People in Making Subjective Judgments," Hoboken, NJ: Wiley-IEEE Press, 2010.
- [19]. Hiroshi Fujimoto and Shingo Harada, "Field and Bench Test Evaluation of Range Extension Control System for Electric Vehicles Based on Front and Rear Driving-Braking Force Distributions," The 2014 International Power Electronics Conference.
- [20]. Rengaraj, Chandrasekaran, "Integration of Active Chassis Control Systems for Improved Vehicle Handling Performance," Doctoral thesis, University of Sunderland 2012.
- [21]. N. Mutoh, H. Akashi, K. Suzuki, T. Takayanagi, "Front and Rear Wheel Independent Drive Type Electric Vehicles (FRID EVs) with Outstanding Running Performance Suitable for Next-Generation Electric Vehicles," Graduate School, Tokyo Metropolitan University 6-6 Asahigaoka Hino-shi, Tokyo, 191-0065 Japan.
- [22]. A. Amirjamshidy, J. Sharifi, "Development of Electronic Stability Control System for Electric Vehicle with Four in Wheel Motors," Journal of Control, Winter 2015.
- [23]. Kasabov, N. K., & Song, Q, "Denfis: dynamic evolving neural-fuzzy inference system and its application for time-series prediction," IEEE Transactions on Fuzzy Systems, 2002. 10(2), 144-154.
- [24]. Wang, L. X, "A course in fuzzy systems," Hong Kong: Prentice-Hall Press 1999.
- [25]. Hagra, H., "Type-2 FLCs: A new generation of fuzzy controllers," IEEE Computational Intelligence Magazine, 2007. 2(1), 30-43.
- [26]. P. Bayat , H. Mojallali , A. Baghrmian , P. Bayat, wo-Surfaces Sliding Mode Controller for Energy Management of Electric Vehicle Based on Multi Input DCDC Converter, International Journal of Automotive Engineering Vol. 5 , Number 2 , June 2016.
- [27]. A. Otadi M.Masih-Tehrani S.M. Boluhari A.Darvish-Damavandi, Determination of the three-axle bus critical speed in the sense of rollover stability respect to the driver command and the road conditions, International Journal of Automotive Engineering Vol. 7, Number 3, March 2017
- [28]. M. Pasandidehpour, M. Shariyat, Multi-objective design optimization for crash safety of a vehicle with a viscoelastic body and wide tapered multi-cell energy absorber using DOE method, International Journal of Automotive Engineering Vol. 7, Number 3, Sept 2016
- [29]. S.Ebrahimi-Nejad, M.Kheybari, Brake System Design for Sports Cars using Digital Logic Method, International Journal of Automotive Engineering Vol. 7, Number 4, Dec 2017
- [30]. Web available at: <http://www.toyotazone.co.za/howitworks/oversteer-and-understeer-explained/>